

ROBAM



If the manual is lost, you can send e-mail to overseas@robam.com, request for an electronic manual.

ZKQS-65-CQ926H01

Combi Steam Oven



Contents

Safety Precautions	1
Product Introduction	4
Installation Instructions	6
Operation Instructions	7
Maintenance and Care	14
Common Faults and Fault Dropping	16
Electrical Schematic Diagram	17









Safety Precautions

In order to avoid any harm or property damage to the users and other persons, following distinctions and signs are specially given. All these are the important notices concerned with safety, so please abide by these notices strictly. And, please use this product correctly on the premise that all the contents herein are understood fully.





Distinctions on contents made in accordance with extent of harm and damage

	Danger	Personal risk, serious injury or a fire may be very likely caused if this sign is neglected and the product is operated improperly.
	Warning	Personal risk, serious injury or a fire may be caused if this sign is neglected and the product is operated improperly.
	Notice	Personal injury or damage to objects may be caused if this sign is neglected and the product is operated improperly.

Signs of the behaviors that shall be paid attention to or that shall be prohibited

							
Prohibited	No open flames	No touch	No remove	Abide by strictly	To be grounded	Electric shock danger	Hot surface

 **Warning** Please use this product strictly in accordance with contents of this Operation Manual. Our company is not reliable for any property loss or personal injury caused by improper using of this product.

 Danger	
	Before disconnecting plug from the socket, you should grip the end of the plug. Be sure not to disconnect the plug with power wire in your hand, otherwise such dangers as electric shock, short out and fire may be caused.
	Be sure not to use a power socket which is loose or contacted poorly, otherwise such dangers as electric shock, short out and fire may be caused.
	The complete appliance shall be kept far away from heat sources and inflammables (e.g. gas and alcohol).
	If the surface is cracked, switch off the appliance to avoid the possibility of electric shock.

 **Danger**



Hot surface

During use the appliance becomes hot. Care should be taken to avoid touching heating elements inside the oven. When taking out foods after using, make sure to wear the high-temperature resistant protective gloves properly in order to avoid burns.

 **Warning**



Abide by strictly

If the supply cord is damaged, it must be replaced by the manufacturer, its service agent or similarly qualified persons in order to avoid a hazard.



To be grounded

Separate use of 16A socket, and be sure not to connect several appliances to the same power socket at the same time, and make sure that the socket is grounded safely and effectively.



Abide by strictly

If the appliance functions improperly, make sure to disconnect it from the power and stop using immediately. And, be sure not to touch the appliance and that it is repaired by a professional.



Abide by strictly

Make sure the power cord is not damaged. When using the power cord, make sure that the cord is not bent, stretched, twisted or knotted. And, Be sure not to press or attack the power cord with weight.



Abide by strictly

In order to protect against, appliance must be kept in clean condition and the air passage must be kept unobstructed.



Abide by strictly









Hot air may come out when door of the appliance is opened after using, so please be sure not to stand too close to the appliance to avoid burns caused by the hot air.













Abide by strictly

WARNING: Accessible parts may become hot during use. Young children should be kept away.

 **Warning**

 Prohibited	<p>This appliance is not intended for use by persons (including children) with reduced physical, sensory or mental capabilities, or lack of experience and knowledge, unless they have been given supervision or instruction concerning use of the appliance by a person responsible for their safety. Children should be supervised to ensure that they do not play with the appliance.</p>
 Prohibited	<p>Do not use harsh abrasive cleaners or sharp metal scrapers to clean the oven door glass, since they can scratch the surface, which may result in shattering of the glass.</p>
 Prohibited	<p>Do not place the flammable substance (such as the smoke agent) inside or under the steam oven. When the appliance is in operation, do not spray smoke agent near the oven. Do not use appliance unattended.</p>
 Abide by strictly	<p>Disconnect the power supply when the appliance is not in use for long time.</p>
 Abide by strictly	<p>Be sure not to operate the appliance when any of your hand or foot is wet or your feet are bare.</p>
 Abide by strictly	<p>Improper use may result in water or gas leak. Contact the qualified service personnel for service.</p>
 Abide by strictly	<p>Turn off the appliance immediately after using, otherwise the residual fat may cause a fire; in case the appliance is not to be used for an extended period of time, please cut off the power.</p>
 Abide by strictly	<p>Make sure to disconnect the electric oven from power before removing the fan guard. After cleaning, reset the guard properly to the original position in accordance with the Operation Manual.</p>
 Abide by strictly	<p>You should cut off the power before cleaning of the appliance and use a neutral detergent to clean it. Moreover, make sure to clean it with a soft piece of cloth, in order to prevent its surface from being scratched.</p>

 Warning	
 Abide by strictly	WARNING: Ensure that the appliance is switched off before replacing the lamp to avoid the possibility of electric shock.
 Abide by strictly	The heating element surface is subject to residual heat after use.

 Notice	
 Abide by strictly	If the appliance functions abnormally, please disconnect the power plug and power it on again.
 Abide by strictly	When using the internal grill, baking tray, steam tray and other placement must positive stop.
 Prohibited	The appliance cannot be used as an indoor heater.
 Abide by strictly	When the water in the drip tray is too excessive, adopt the absorbent cotton or cloth to absorb the water.
 Prohibited	The steam cleaner is not to be used.
 Prohibited	The appliance must not be installed behind a decorative door in order to avoid overheating.
 Abide by strictly	This appliance just for household use only.

Product introduction

Dear users:

We take this opportunity to express our heartfelt thanks to you for your choosing of ROBAM brand Combi Steam Oven series products. We especially recommend that you shall read this Manual carefully before installing and using this product and keep it properly for later reference.

The company is a professional manufacturer of household appliances and kitchenware such as range hoods, all-in-one steaming and baking machines, gas stoves, disinfection cabinets, electric ovens, etc. The Robam brand all-in-one steaming and baking machine adopts advanced design concept, paying attention to overall design and optimizing modeling. It has the advantages of health, environmental protection, energy saving, etc.

This appliance is classified as class I appliance, It must be grounded when in use.

※The pictures of the products in this manual are for reference only, and the products are subject to the actual objects. The company's products continue to improve, and changes in content due to product improvement will be made without prior notice.

Important Information

Packaging of Combi steam oven

Please dispose these packaging materials in an environment-friendly way, in order to keep a good environment.

Be sure not to allow children to play with the packaging materials (e.g. plastic film and carton box, etc.), otherwise it would lead to suffocation accident. So, please keep children away from the packaging materials.

Product Structure

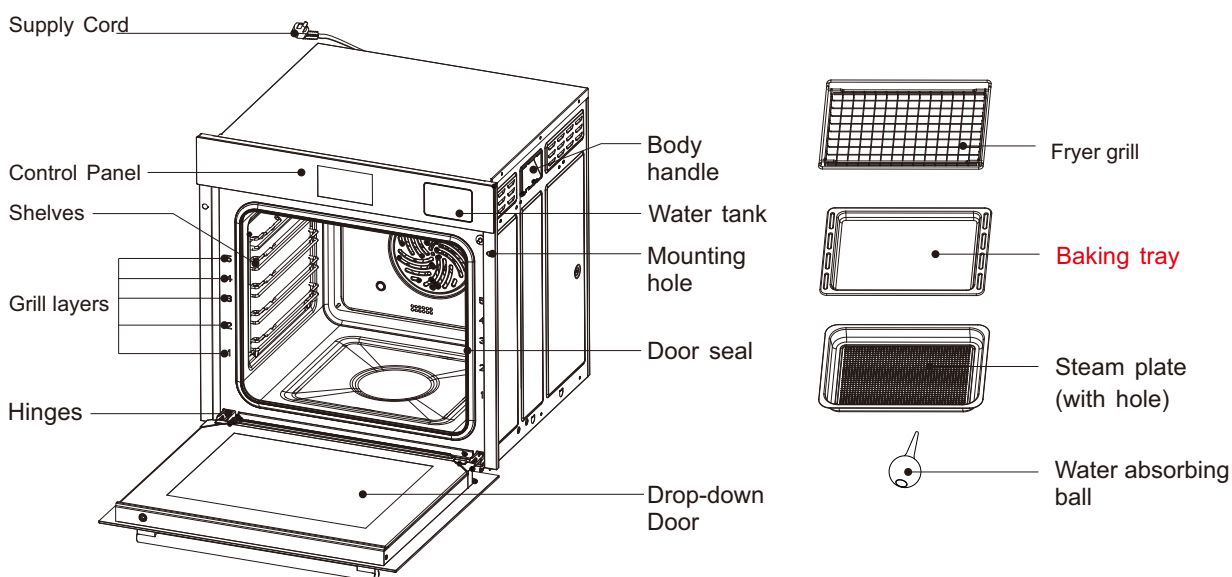

Note: According to the cooking needs, you can place the frying grid, shallow baking tray, perforated steam tray smoothly between 1, 2, 3, 4, 5 shelf track, and push to the bottom.

Technical Parameters of the Product

Model	ZKQS-65-CQ926H01
Rated Voltage	220-240V~
Rated Frequency	50-60Hz
Rated Power	3250W
Capacity	65L
Total volume	73L
Net Weight	41kg
Dimensions(mm) W×H×D	530×360×400

List of Accessories

S/N	Name	Quantity
1	User Manual	1Pcs
2	ST3.5×30自攻螺钉	2Pcs
3	Fryer grill	1Pcs
4	Baking tray	1Pcs
5	Steam plate (with hole)	1Pcs
6	Descaling agent	1Pcs
7	Shelves	1Pcs
8	Water absorbing ball	1Pcs

Installation Instructions

Follow below illustration to set the square hole at the setting position of the cabinet. Insert the combi steam oven steadily into the square hole in place. Do not place the oven inclined. Detailed hole size (mm), refer to the below table:

S/N	Name	A	B	C
1	Dimensions of the hole for full insertion (WxHxD)	600	600	565
2	Dimensions of the hole for semi-insertion (WxHxD)	560	590	550

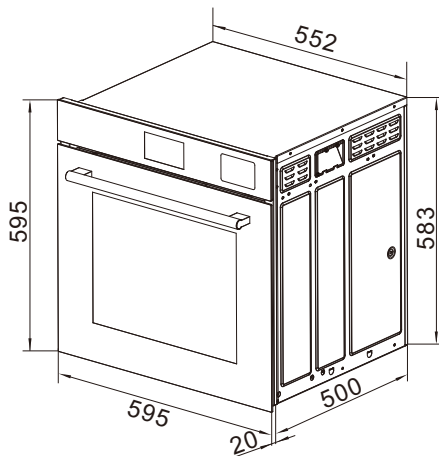

Complete dimensions diagram

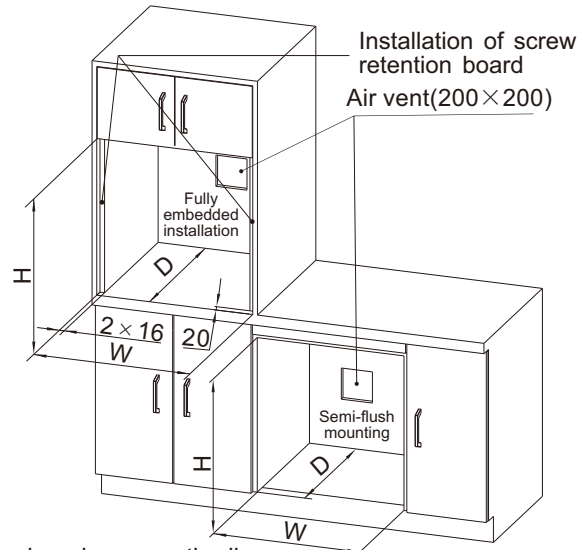

Opening size synoptic diagram

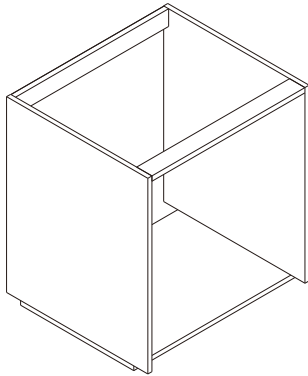

Side view

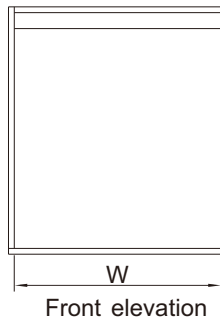

Front elevation

Note: When the product installation position for the floor cabinet, in order to ensure that the product door body and the left and right cabinet doors to form an overall consistent visual effect, it is recommended to use the floor cabinet structural drawing shown on the left.

Installation Requirements:

- The cabinet surface or table top to place the combi steam oven must be flat.
- Make sure the air circulation as much as possible around the steam oven inside the cabinet. Recommend the clamp plate and fixing plate to adopt the moisture proof, water proof, anti-corrosion and high temperature resistant material.
- Use the two mounting screws provided to fix the unit onto the cabinet through the mounting holes on the left & right door frames.

Power Supply Requirements:

- For permanent installation, the electrical circuit must have the disconnecting and protecting device. The power connection plug and outlet should be of the same model and compliant with the local regulations.
- The power plug connection must be convenient. Make sure the steam oven can be disconnected as necessary from time to time after installation. Use a 16A outlet alone, do not use the same electrical outlet with several appliances at the same time, and make sure the outlet is safely and effectively grounded.
- If any other electric appliance nearby, make sure the installation distance is more than 100mm.

Operation Instructions

Introduction to Control Panel

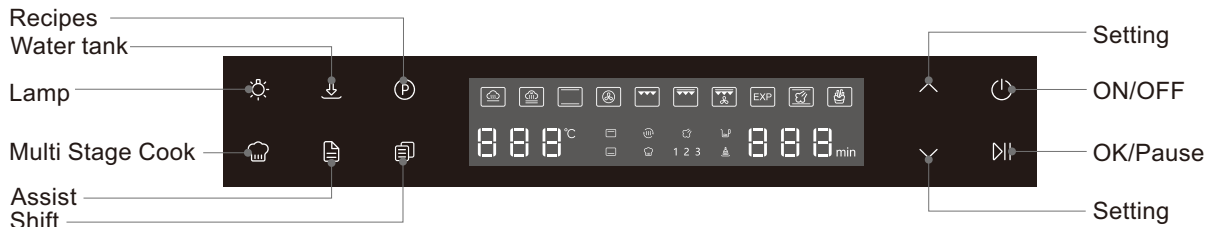

Pre-use instructions

When the new product is used for the first time, because the evaporation of the protective coating of heating element will produce peculiar smell, so under the condition of ensuring that the surrounding environment of the product is well ventilated, fill the water tank with water, first choose nutrient steaming at 100°C, 10min, after the work is over, then choose wind Baking mode 200°C, 20min, all work is completed until the machine is cooled, use a damp rag to wipe and clean the inner tank, and subsequent cooking can be carried out normally.

Water tank filling and installation precautions:

1. In the power-on state, press “↓” key, the water tank automatically popped up, take out the water tank (As shown in the picture on the right).
2. Check whether the water tank is clean before use, or whether there are foreign objects blocking the water inlet, such as odor or dirt, please promptly clean, do not clean with boiling water.
3. Open the water tank cover to add water to the tank, do not exceed the maximum water level.
4. Push the water tank after adding water into the tank slot, and there will be a chirping alert when the tank is pushed into place.

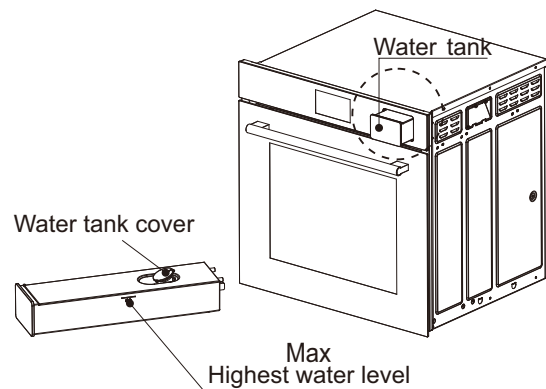

Note:

- It is forbidden to add hot water into the water tank to avoid deformation of the water tank and damage to the machine.
- The display will show a "water shortage" alarm when there is a water shortage at work.
- All use of steam function or humidification function, after shutdown, the pump starts for residual water recovery.

Warm Tip: When using the product, it is recommended that you turn on the range hood.

Using Methods

1. Power on

Turn on the power, a beep sound, all lights on. After a few seconds, the “⏻” key flashes.



Note: If there is no operation within several minutes, enter the shutdown state, all the lights go out, long press “⏻” key to enter the power on state.

2. Turn on

Long press the “” key to turn on the power and enter the default mode.



3. Choose a cooking method



Users can choose different modes to cook food according to their needs.



Steam mode / Baking mode / Fried mode



Steaming modes are: nutritional steaming, high temperature steaming

Roasting modes are: roasting, wind roasting, roasting and burning, strong roasting and burning, fan roasting, professional roasting, humidified roasting

Frying modes are: air frying





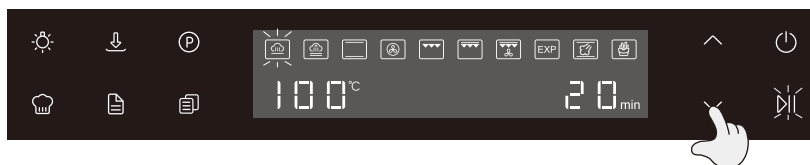

① In the mode selection status, press “” or “” key to select the desired mode, the selected mode icon flashes.

② To adjust the cooking temperature or time, press the “” key to switch to the temperature or time display area, and then press the “” or “” key to adjust;

③ After the setting is completed, press “” key to start, automatically enter the preheat mode, when the preheat temperature is reached a beep, press “” key to pause, at this time the food into the inner cavity, and then press “” key to start, when the work is completed, the buzzer beeps to indicate.



Note:

- After cooking in steam mode, it is recommended to dry the inner cavity or use the drying function to dry. If you do not need to adjust the temperature and time, you can directly press “” button to start after the mode selection;
- Set the cooking temperature and time, users can adjust the temperature and time according to the cooking reference table, and also according to personal taste and cooking experience;
- During temperature and time adjustment, long press “”, “” keys for continuous increment or decrement;
- Press the “” key to cycle through the mode display area, temperature display area and time display area.
- Part of the mode has cooking memory function, in the state of unplugged, the last working cooking mode can be remembered when the power is turned on again.
- Steam mode will be locked one minute after the work starts, the user cannot open the door of the machine, you must press the “” key to open the door; the door lock will open automatically when the work is finished, the user should pay attention to the steam when opening the door to avoid burns.
- When using the grill mode, it is recommended that the user place the food on the third shelf.
- After using the steam mode, it is recommended that the remaining water at the bottom of the chamber be cleaned up.
- The water tank is not installed in place or the door of the machine is not closed tightly, and the work cannot be started by pressing the “” button, please check the condition of the water tank and the door.

Multi-stage mode

In order to meet the diversified taste of users, the special multi-stage mode can set two different modes for cooking food.

For example, the first section selects high-temperature steaming, the second section selects wind roasting, and the third section selects air frying, operating as follows.

First paragraph setting

Press “👤” key to enter the first cooking setting, then press “^” or “v” key to select “high temperature steaming” mode; if you want to adjust the cooking temperature and time, press “📄” key to switch to the temperature or time display area, then press “^” or “v” key to adjust. To adjust the cooking temperature and time, press “📄” key to switch to the temperature or time display area, and then press “^” or “v” key to adjust. (If there is no need for the second and third section, press “▶||” key to start after setting).

Second paragraph setting

Press “👤” key to enter the second cooking setting, press “^” or “v” key to select “wind roast” mode, if you want to adjust cooking temperature and time, press “📄” key to switch to temperature or time display area, then press “^” or “v” key to adjust. (If there is no need for the third section, press “▶||” key to start after the setting is completed).

Third paragraph setting

Press “👤” key to enter the third cooking setting, press “^” or “v” key to select “air fry” mode, if you need to adjust the cooking temperature and time, press “📄” key to switch to the temperature or time display area, then press “^” or “v” key to adjust, after the setting is completed, press “▶||” key to start.

Note:

- Exit multiple segments by pressing “👤” briefly under the third segment selection page only.
- Multi-segment ability to select all master modes.
- Multi-segment can be paused and the time of the current mode can be adjusted.

Recipe

Built-in 56 automatic recipes, one key cooking, convenient and quick.

- ① Press the “Ⓟ” button to enter the menu.
- ② Press “^” or “v” key to select the desired recipe, corresponding to the following table.
- ③ If you need to adjust the time, press “📄” key time display area flashing, then press “^” or “v” key to adjust the working time within a certain range.
- ④ Finally press “▶||” button to start and begin cooking.









P01 Basque Burnt Cheesecake	P06 Roasted Duck with Fruit	P11 Thai Chicken Wings with Lemon
P02 Brownie Cake	P07 Easy Baked Pasta	P12 Wellington Salmon Pie
P03 Slow Roast Beef Tenderloin	P08 Grilled chicken with lemon and herb sauce	P13 Italian Roast Chicken
P04 French Apple Pie	P09 Chocolate Mousse Cake	P14 Italian Eggplant Cheese
P05 Raspberry French brioche	P10 Roasted potatoes with garlic	P15 Spaghetti

Note:





- Some recipes require food to be taken out for processing in the middle of the recipe, the machine will beep to remind the user.
- For recipe details, please scan the small program code on the product.

Auxiliary mode

The auxiliary modes are: 01 defrosting, 02 fermentation, 03 holding, 04 cleaning, 05 drying, 06 sterilization, 07 descaling.

- ① Press the “” button to enter the auxiliary mode.
- ② Press the “” or “” key to select the desired mode.
- ③ If you need to adjust the mode working parameters, press “” key to switch to the temperature or time display area, then press “” or “” key to adjust the working parameters within a certain range.
- ④ Finally, press “” to start and start working.

Cleaning mode







The mode is divided into two sections, press the “” key, then press the “” or “” key to select the “04” cleaning mode, and then press the “” key to start working, the display screen displays “1” and the corresponding time, after the completion of the first section Automatically enter the pause state, the buzzer beeps the prompt, the display screen displays “2”, and then press the “” key to continue the work, the second paragraph is mainly for drying, and the tweet prompt after completion.

Note:

- cleaning, drying, sterilization, descaling mode is not adjustable temperature and time, holding mode is not adjustable time.
- It is recommended to use the dry mode, open the door to dry better; (before starting the dry mode, use a rag to wipe clean the inner liner to remove the inner liner dirt and water stains)



Descaling mode

The mode is divided into three sections (the first section for descaling, the second and third section for rinsing), add 30 grams of scale dissolver to the tank before use, and fill the tank with warm water to the highest water level line.

- ① Press “” key, then press “” or “” key to select “07” descaling mode, then press “” key to start working, the display shows “1” and the corresponding icon, the first section is completed automatically into the pause state, the buzzer beeping prompt, the display shows “2”, at this time take out water tank to pour out the remaining water, then add water to the highest water level line, put it into the water tank, press “” key to start working.
- ② automatically enter the pause state after the completion of the second paragraph, the buzzer beeping prompt, the display shows “3”, then take out the water tank to dump the remaining water, and then add water to the highest water level line, into the water tank, press “” key to start working.
- ③ After the third section is completed, the buzzer beeps to indicate the end of the work into the standby state.

Note:The steam function will remind the user to descale after the accumulated work to a certain time, at this time out of run steam function, please descale.

■ Adjust settings

In the working process, if you want to change the set mode, temperature and time, please press “” key first to stop working, in the adjustable state, at this time you can reset the mode, temperature and time, after the adjustment is complete, then press “” key to start working.

■ Light used

In the power on state, you can press “” key to turn on the lighting, and then press this key to turn off the lighting, if not, it will go off automatically after several minutes.

■ Power-off

1. When the work is finished, the buzzer will beep to indicate the shutdown state;
2. Standby state, the state without any operation, automatic shutdown after a few minutes;
3. In the working process, long press “

Note:

- If the internal temperature of the product is too high, the cooling fan will delay for a period of time and then stop running, which helps to extend the life of the machine.
- In order to shorten the heat dissipation time, it is recommended to open the product door completely when heat dissipation.

Mode Menu

Mode	Default working temperature (°C)	Default working time (min)	Temperature range (°C)	Time range (min)
Delicate	100	20	96-105	1-120
Rich	120	20	106-150	1-120
Baking	160	30	35-250	1-120
Convection	200	30	35-250	1-120
Grillingl	180	30	35-250	1-120
Maximum Grill	180	30	35-250	1-120
Fan Gril	220	30	35-250	1-120
EXP	Upper160、Lower140	20	100-220	1-120
Humidified baking	200	30	35-250	1-120
Air Fry	200	30	35-250	1-120
Defrozen	60	30	50-70	1-180
Ferment	30	40	30-45	5-720
Warm	60	120	50-70	-
Clean	-	-	-	-
Dry	-	10	-	-
Sterilize	100	20	-	-
Descale	-	-	-	-

Note:

- Users can understand the heating mode according to this table and choose the suitable baking function.
- It is recommended to reduce the fermentation time of the dough in summer, 30min-35min is recommended.

Cooking Reference Table

Mode	Food	Cooking layer position	Apparatus used	Temperature (°C)	Cooking time (min)	Remarks
Delicate	Egg custard	3	Steam plate (with hole)	96	20	2 eggs, egg-water ratio 1:2
	Hairy Crab	3	Steam plate (with hole)	96	23	About 100g/each, 10 pieces in total
	Fish Head	3	Steam plate (with hole)	96	24	Approximate weight 700g
	Scallops	3	Steam plate (with hole)	96	17	Approximate weight 350g, cut into pieces
	Perch	3	Steam plate (with hole)	100	15	Approximate weight 400g, fish back graver
	Minced Shrimp	3	Steam plate (with hole)	100	10	Approximate weight 400g
	Whole chicken	3	Steam plate (with hole)	100	40	Approximate weight 1000g
	Spare Ribs	3	Steam plate (with hole)	100	30	Approximate weight 550g, cut into pieces
	Meatloaf	3	Steam plate (with hole)	100	16	Approximate weight 350g, minced meat
	Chunks of meat	3	Steam plate (with hole)	100	25	Approximate weight 500g, cut into pieces
	salami	3	Steam plate (with hole)	100	15	Approximate weight 200g, sliced
	Sweet Potato	3	Steam plate (with hole)	100	25	Approximate weight 1000g, total 9 pieces
	Corn	3	Steam plate (with hole)	100	20	Approximate weight 1500g, total 4pcs
	Long eggplant	3	Steam plate (with hole)	100	13	Approximate weight 350g, cut into pieces
	Rice	3	Steam plate (with hole)	100	30	Rice weighs about 300g, rice to water ratio 1:1.2
Rich	Handmade Steamed Buns	3	Steam plate (with hole)	96	28	80g/pc, 8pcs
	Instant Frozen Dumplings	3	Steam plate (with hole)	100	13	1 full plate
	Silver Ear	3	Steam plate (with hole)	110	100	Dried silver fungus weighs about 15g
	Eisin	3	Steam plate (with hole)	120	90	Approximate weight 500g, chopped
	Duck meat	3	Steam plate (with hole)	150	25	Approximate weight 1000g, chopped
	Brisket	3	Steam plate (with hole)	120	90	Approximate weight 400g

Mode	Food	Cooking layer position	Apparatus used	Temperature (°C)	Cooking time (min)	Remarks
Baking/Convection	Chicken wings	3	Fryer grill +Baking tray	180-230	10-30	Approx. weight 700g, 15 pieces
	Chiffon Cake	3	Fryer grill	140-160	40-60	Chiffon Cake 8 inch
	Cupcake	3	Baking tray	135-160	25-60	Cupcake 14pcs
	Cookies	3	Baking tray	155-175	15-30	1 full plate
	Egg Tart	3	Baking tray	205-225	15-30	15 medium-sized egg tarts
	Soufflé	3	Baking tray	180-200	20-40	16 egg yolks
	Small bread	3	Baking tray	150-180	20-35	Whole plate 1 plate, 12 pcs
	Pizzas	3	Fryer grill	205-215	10-25	Frozen pizza crust 8
Grilling/Maximum Grill	Steak	3	Baking tray	200-230	5-10	Approximate weight 200g/block
	Meat skewers	3	Baking tray	170-190	15-30	Approximate weight 500g
	Grilled Shrimp	3	Baking tray	180-220	8-20	Approximate weight 400g
Fan Grill	Whole chicken	3	Fryer grill +Baking tray	150-180	45-60	Approximate weight 1100g
	Kebabs	3	Baking tray	180-210	10-25	Meat skewer 12 skewers
	Grilled Fish	3	Baking tray	190-230	20-35	Grass carp weighs about 1500g/pc
Air Fry?	French fries	3	Fryer grill	190-215	15-30	Frozen French fries weigh about 250g
	Chicken Rice Flower	3	Fryer grill	190-215	15-30	Frozen chicken rice flower weighs about 400g
	Youtiao	3	Fryer grill	200-220	5-15	Frozen doughnuts 5pcs
	Chicken whole leg	3	Fryer grill +Baking tray	175-200	35-60	Approximate weight 600g, total 2pcs
Humidified baking??	Sweet Potato	3	Baking tray	220-250	40-60	Approximate weight 1000g
	Chum Salmon	3	Baking tray	200-230	10-20	Approximate weight 400g
	Pacific saury	3	Fryer grill +Baking tray	190-210	15-25	Approximate weight 400g, 6 strips in total
	French style lamb chops	3	Baking tray	190-220	10-25	Approximate weight 500g, total 6 pieces
Multi-stage	Ribs	3	Steam plate (with hole) +Fryer grill	Delicate 105°C 12min Maximum Grill 210°C 15min	20-40	Approximate weight 1000g, 4 sticks in total
	Pipa Legs	3	Fryer grill +Baking tray	Baking 220°C 15min Delicate 105°C 20min	30-50	Approximate weight 1000g, total 6pcs
	Elbow	3	Fryer grill +Baking tray	Delicate 105°C 70min Maximum Grill 230°C 30min	80-130	Approximate weight 1500g, whole
	Whole Duck	3	Fryer grill +Baking tray	Delicate 105°C 70min Fan Grill 215°C 20min	75-110	Approximate weight 2000g, whole
	Hand Baked Buns	3	Baking tray	Delicate 100°C 12min Baking 230°C 15min	20-40	Whole 1 plate, 20 pcs

Note:

- The above table of food cooking temperature and time are for reference only. During the cooking process, users can adjust the temperature, time and mode according to their personal taste and cooking experience.
- Before baking food, the user of the food to be marinated can be marinated with the prepared ingredients for about 30min-40min, which can make the food more flavorful.
- For even heating during baking, it is recommended to turn the food over.

Common Baking Symptoms and Remedies

Symptoms	Possible Causes	Remedies
Baking is uneven	<ul style="list-style-type: none"> *Incorrect baking layer position *Food is not placed in the center of the baking tray *Incorrect function selection 	<ul style="list-style-type: none"> *Select the appropriate baking layer position *Place the food in the center of the baking tray *Correct function selection
Upper surface color or bottom color of the baked foods is burned	<ul style="list-style-type: none"> *Incorrect function selection *Food is not of the same size or not evenly distributed *Baking temperature is too high *Baking layer position too high or too low *The number of times the door of the all-in-one machine is opened during baking is too much 	<ul style="list-style-type: none"> *Correct function selection *Food is cut evenly and placed evenly on the steam tray *Reduce the temperature *Change the position to a lower or higher layer *Bake at least half the time before opening the door once
The baked cake has cracks or thick crust	<ul style="list-style-type: none"> *The baking time is too long *Baking temperature is too high *Bake recipe or preparation method is incorrect *Selected container is improper 	<ul style="list-style-type: none"> *Adjust the baking time *Lower the temperature *Adjust recipe and adopt correct preparation methods *Replace with a proper container
The baked foods are light-colored or under-baked	<ul style="list-style-type: none"> *Baking temperature is too low *Baking time is too short 	<ul style="list-style-type: none"> *Adjust the baking temperature *Extend the baking time

Maintenance and Care

Important: Before cleaning the steam baking and frying machine, you must first power dump. Must always keep the appliance clean to ensure that there is no accumulation of fat and grease around the heating element, fan; baking pans and grills, etc. must be cleaned to avoid the accumulation of fat to trigger a fire; meat can be wrapped in aluminum foil while baking for cleaning; any fat and grease will form a lacquer-like layer inside the appliance and be difficult to clean, so it should be cleaned after each use.

1. Inner cavity: clean with warm water, do not use cleaners with corrosive nature and with abrasive property. Difficult to remove stains can be cleaned with a nylon brush or neutral detergent, do not scrub with a wire ball to avoid irreparable damage to the surface. Cleaner inside the cavity must be cleaned without residue, clean and dry with a rag to keep the cavity dry, or use the drying function to dry.
2. glass face plate: door and control panel on the glass surface as soon as the dirty should be cleaned, firm dirt can be cleaned with neutral detergent, do not use wire balls to scrub, so as not to scratch the surface, wipe dry with a rag after cleaning.
3. After each use, please take out the water tank to pour out the water to avoid time will produce odor.

4. The water in water collecting sump must be cleaned up in time after use to prevent water from overflowing.
5. Remove and install the fan cover: the fan cover is fixed inside the cavity with 4 nuts, and the fan cover can be removed by turning down the nuts counterclockwise.

Note: Be sure to re-install the fan cover after cleaning.

6. Remove and install shelves (left and right shelves in the same way): press the position of shelf ① (Figure 1) until the shelf leaves positioning screw, and remove it upward according to the arrow in (Figure 2), that is, it can be disassembled. Reassemble the shelf, press (Figure 2) the lower end of the shelf aligned with the screws 1, 2 inserted, and then the upper end of the shelf snap into positioning screw can be.

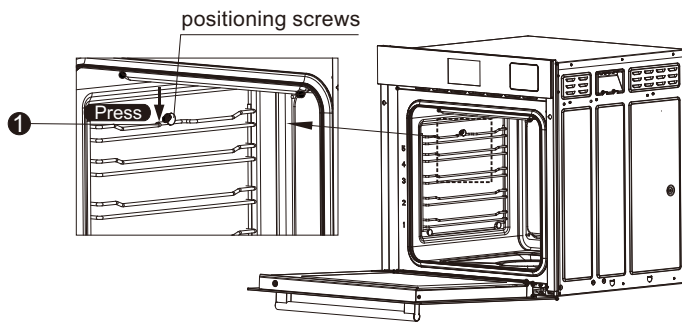

Figure 1

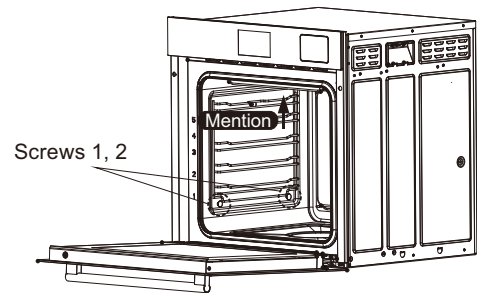
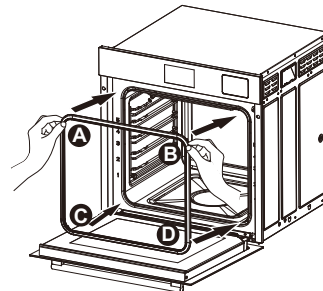
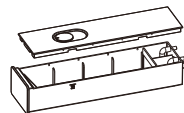

Figure 2

7. Installation method of the door seal, pinch the two A and B semicircular corners on the top and left of the door seal with both hands, align with the semicircular corner grooves on the upper side of the front panel, and press them hard; at the semicircular corners, align with the semicircular grooves under the front plate, and press them hard; then completely press the four sides into the grooves respectively, and ensure that they are flat, wrinkle-free and seamless after pressing in.

8. When adding water or cleaning the water tank, you can open the upper cover of the water tank for operation.



Common Faults and Fault Dropping

The following table lists common faults. Please confirm and handle them according to the listed instructions. If the fault cannot be handled or the cause cannot be confirmed, please contact the local dealer or after-sales service center. For the sake of your safety, we specially remind you not to disassemble and repair it yourself.

Failure phenomenon	Reason	Processing method
Can not work	Power cut off, or power plug was not plugged in	Make sure the power is on, or try to plug in again
The display is not bright	Power failure or computer board failure	Check the power supply or ask a professional to repair it
The lights are not on	Power failure or bulb failure	Check the power supply or ask a professional to repair it
There is leakage of air and water at work	The door is not tightly closed, the door seal is not in place or the door seal is damaged	Check the door closure, reinstall the door seal or contact professional maintenance personnel
The display shows "water tank is short of water"	The water tank is short of water or the water level detection switch and water pump fail	Add water or contact professional maintenance personnel
	Not identified to the water tank, the water tank is not installed or not installed in place	Correctly install the water tank, if the installation is still flickering Please contact professional maintenance personnel
Water tank can not be popped	Pusher motor failure, computer board failure	Please contact professional maintenance personnel
The display shows E5	The temperature sensor of the box is faulty, the computer board is faulty	Please contact professional maintenance personnel
Display shows E6	Communication failure (display board connection line abnormal), computer board failure	Please contact professional maintenance personnel
Display shows E7	Upper fan failure	Please contact professional maintenance personnel

Warning: Before use, please push the water tank into place; during cleaning, please do not block the water inlet with foreign objects.

Electrical Schematic Diagram

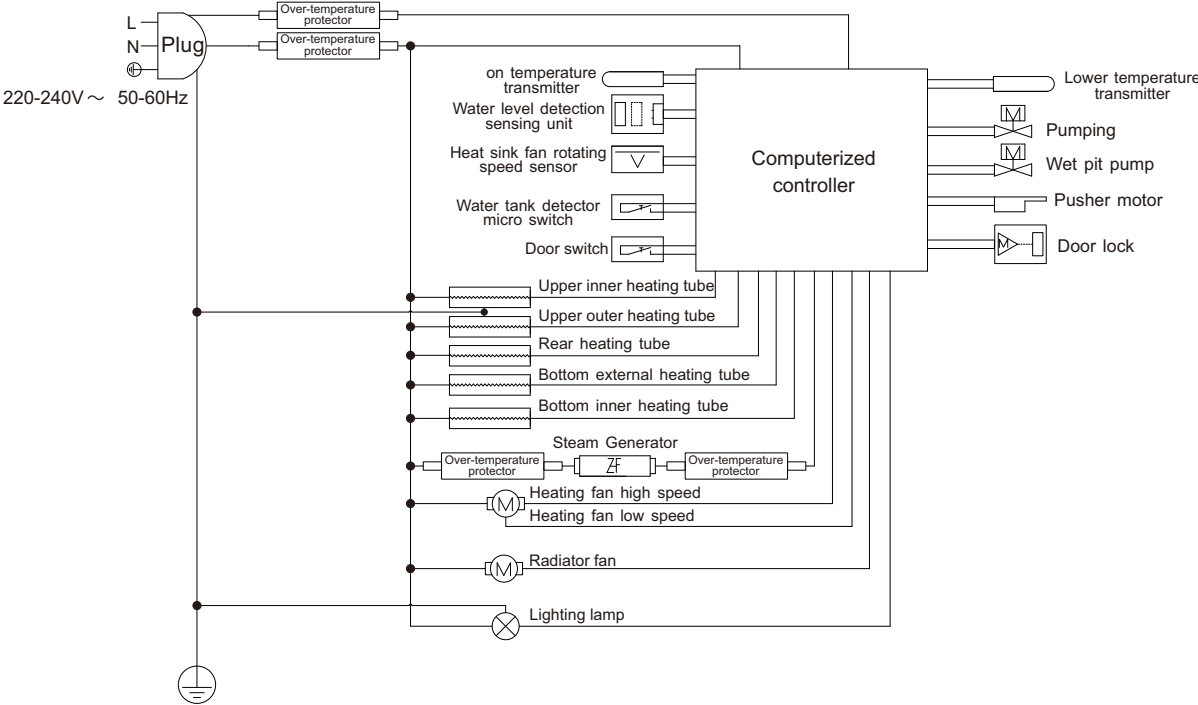

Edition: A/0
Publication Date: Sept,20,2022

ROBAM