

ROBAM



User Manual

Before operating this unit, please read the user manual completely and keep it. If the manual is lost, you can send e-mail to overseas@robam.com, request for an electronic manual.

CXW-200-A8303

CXW-200-A8323

Range Hood

CONTENTS

Safety Precaution.....	1
Important Information.....	4
Product Description.....	5
Packing List.....	5
Installation.....	6
User Manual.....	14
Maintenance.....	15
Removal of Components.....	15
Circuit Diagram.....	17
Troubleshooting of General faults.....	18

Dear users:



Thank for your buying our range hood. Please accept our best regards. Please read this user manual carefully before installation and operation.

*The pictures in this manual only for your reference. If the picture isn't accord with object, subject to object. We keep to right to update appearance, structure or products without notice.

Safety Precaution

In order to avoid harm or property damage to the users or other person, the following distinction and marks are stipulated. They are important safety precaution, please comply strictly based on the full understanding.

Subject to harmful or destruct degree







 Danger	If ignore this sign and operate product improperly, it's highly possible to cause danger, serious injury or fire.
 Warning	If ignore this sign and operate product improperly, it's possible to cause danger, serious injury or fire.
 Notice	If ignore this sign and operate product improperly, it's possible to cause injury or loss.

Notice and Prohibit Mark

 Prohibit	 Prohibit Flame	 Prohibit Touch	 Prohibit Touch by Wet Hand	 Prohibit Disassembly	 Strict Execution	 Necessary Earthed	 Caution Electric Shock	 Caution Scald
---	--	--	--	--	--	--	--	---

 Warning Please use this product according to manual strictly, or ROBAM shall not take any responsible caused by improper operation.

Danger

 Prohibit	Don't allow children or weakling to use range hood separately, or it may cause electric shock or other accident.
 Prohibit	Prohibit water on motor, switches or other electric parts; Prohibit wash range hood by water spray. Don't use range hood if wet or it may cause electric leakage or shock.
 Prohibit	Don't change, stretch, bind or press electric wire, or it's possible to cause electric shock or fire because of broken wire.
 Prohibit	Prohibit any change of interior circuit, or it may cause injury or other danger, for example, electric shock or fire.
 Prohibit Touch by Wet Hand	Don't touch plug, electric parts or button by wet hands, or it may cause electric shock.
 Strict Execution	Unplug before cleaning, installing or maintaining, avoiding from electric shock.

Danger

Strict
Execution

Please turn off range hood immediately if pan got fire (range hood shall aggravate fire if it's working) and extinguish fire by effective action. For example, cover flame by metal cover, turn off gas valve immediately and remove inflammable things.

Strict
Execution

Any abnormal, please turn off power, take off plug or cut off electric source, and contact service. It's possible to cause electric shock or fire if using range hood under abnormal situation.

Warning

Prohibit
Disassembly

Range hood must be installed, disassembled or maintained by professional person.

Prohibit

Stove fire shall be extinguished timely when it is not used; do not flambe under the range hood and it's prohibited to bake food under range hood directly to prevent range hood from damaging and causing accidents.

Prohibit Touch

Don't touch bulb if it's on or just close in short time, or it may cause scald.

Strict
Execution

In order to ensure safety, range hood must be installed by specific accessory (especially expansion pipe and wooden screws, or it may cause accidental drop of range hood). The pipe bore and hole must fit tightly during the installation of metal expansion pipe. It is prohibited to make excessively large hole to prevent accidental drop of loosening expansion pipe.

Strict
Execution

The range hood must be used by specific plug and properly ground it. It's possible to cause electric shock, hot plug or fire because of improper electric wire. Installation must be executed by professional person based on local electrical regulations. Before connect electricity, power must be turned off.

Strict
Execution

If the supply cord is damaged, it must be replaced by the manufacturer, its service agent or similarly qualified persons in order to avoid a hazard.

Strict
Execution

All operation must comply with our safety guidelines as well as local safety regulations.









Strict
Execution

There shall be adequate ventilation of the room when the range hood is used at the same time as appliances burning gas or other fuels.



Strict
Execution

This appliance just for household use only. And it's not allowed to exhaust dangerous or explosive matter or air. It should be put under dry and ventilation environment without dangerous air.







Warning

 Strict Execution	The range hood and electric circuit must be installed by skilled and trained personnel with required qualification. When installation, the related regulation, standard or instruction on fire must be complied. It may cause danger because of improper installation, for example, electric shock, drop or fire accident.
 Strict Execution	The outlet must be connect with outside. In order to ensure safety and fresh air, waste gas should be exhaust to outside. Don't exhaust waste gas to the wall, loft or garage.
 Strict Execution	There is a fire risk if cleaning is not carried out in accordance with the instructions.
 Strict Execution	Keep a good habit to turn off gas hob and gas valve if go outside, sleep or finish operation. Replace or check gas pipe regularly, since gas alarm device can't completely avoid accident caused by gas leakage.
 Strict Execution	This appliance is not intended for use by persons (including children) with reduced physical, sensory or mental capabilities, or lack of experience and knowledge, unless they have been given supervision or instruction concerning use of the appliance by a person responsible for their safety. Children should be supervised to ensure that they do not play with the appliance.
 Strict Execution	The minimum distance between the supporting surface for the cooking vessels on the hob and the lowest part of the range hood. When the range hood is located above a gas appliance, this distance shall be at least 650mm. If the instructions for installation for the gas hob specify a greater distance, this has to be taken into account.
 Strict Execution	Range hoods and other cooking fume extractors may adversely affect the safe operation of appliances burning gas or other fuels (including those in other rooms) due to back flow of combustion gases. These gases can potentially result in carbon monoxide poisoning. After installation of a range hood or other cooking fume extractor, the operation of flued gas appliances should be tested by a competent person to ensure that back flow of combustion gases does not occur.

Notice

 Prohibit	The air must not be discharged into a flue that is used for exhausting fumes from appliances burning gas or other fuels, the discharge of air must fulfill the requirements of local regulations.
 Strict Execution	Before removing range hood for installation, clean or maintainance, power must be cut off avoiding from electric shock. When installation, clean or maintainance, protective gloove must wear avoiding from injury.

Notice

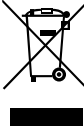
 Strict Execution	<p>The temperature for range hood working can't exceed 40°C.</p>
 Strict Execution	<p>Because the installation is difficult and hood is heavy, the installation shall be executed by professional person based on manual.</p>
 Strict Execution	<p>Don't break electric wire or other invisible equipment when cutting something or drilling holes on ceiling.</p>
 Strict Execution	<p>When range hood is using in well sealed building, it should have air inlet or open door to ensure good ventilation.</p>
 Strict Execution	<p>When the oil exceeds 2/3 or near tick mark in the oil cup, clean it in time. Don't eat waste oil from oil cup.</p>
 Strict Execution	<p>The wall of installing range hood needs enough strength. For hollow walls, the thickness of solid layer of hollow wall must be more than 30mm, but for concrete walls, it can be drill holes directly. The range hood must be fixed on the wall firmly.</p>
 Strict Execution	<p>Accessible parts may become hot when used with cooking appliances.</p>
	<p>DISPOSAL: Do not dispose this product as unsorted municipal waste. Collection of such waste separately for special treatment is necessary. This product must not be disposed together with the domestic waste. This product has to be disposed at an authorized place for recycling of electrical and electronic appliances. By collecting and recycling waste, you help save natural resources, and make sure the product is disposed in an environmental friendly and healthy way.</p>

Important Information

Package of Range Hood

Please settle those packages carefully in order to protect environment. Don't allow children to play plastic film and package, it may cause asphyxia. Please avoid children near package material.

Before use Range Hood

This range hood exhaust fume outside. Please read this manual and all information carefully before installation and operation. Please comply with our suggestion. If it's necessary, please read manual for gas hob. And please keep these manual carefully for future reference. If range hood has obvious damage, please don't electrify and contact operator. This manual is available for different models. So you may find different description with your own range hood.

Product Description

Technical Data

Model	CXW-200-A8303 CXW-200-A8323	Rated Power Input	202W
		Rated Main Motor Power Input	200W
Rated Voltage	220-240V~	Dimension (L×W×H)	A8303:595×510×560(mm)
Rated Frequency	50Hz		A8323:895×510×560(mm)
Nominal Wind Pressure	500Pa	Net Weight	A8303:21.6kg A8323:23.6kg
Max static pressure	1000Pa	Noise	59dB(A)
Airflow	1180m ³ /h		

Note: 1. The performance test results are all in 230V~50Hz power supply environment. The noise is according to IEC60704.
 2. The determined value of nominal wind pressure,max static pressure shall not be less than 90% of declared value.
 3. The noise declared value shown is A weighted sound pressure level.

Body Size



The marked sizes are for reference only, dimensions of A8323 in parentheses, the depth dimension includes machine feet.
 (Unit: mm)

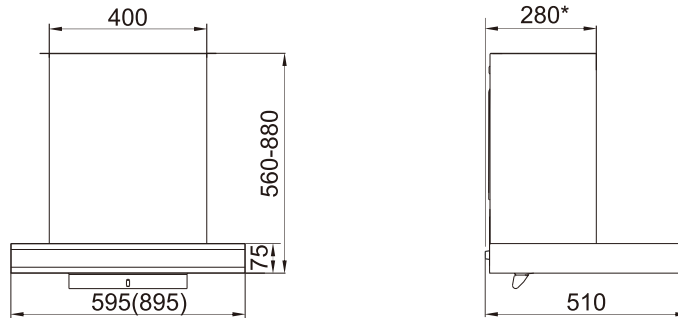



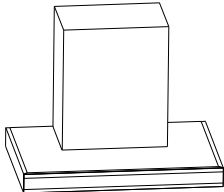

Note: The size inside the cabinet should be larger than the size of the belt *.

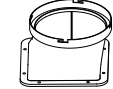
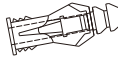
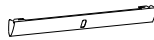
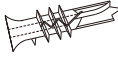
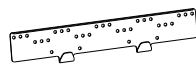

Packing List

Please check the items in the container upon unpacking

Standard Offerings			
 Range hood	1	 Flexible aluminum duct	1
		 User Manual	1

 Check valve	1	 Plastic expansion pipe (tile)	4
 Oil cup	1	 Plastic expansion pipe (Plasterboard)	4
 Hitching leg	1	 4x60 wood screw	4
 Hitching leg stop block	1	 ST4.2x18 self tapping screw	10
 M6 metal expansion pipe	1	 ST4.2x8 self tapping screw	6
 Gasket	1		

Note: Please mount the oil cup in the container on the mesh enclosure when to use the machine.

Installation

Warning

- 1.The air must not be discharged into a flue that is used for exhausting fumes from appliances burning gas or other fuels, the discharge of air must fulfill the requirements of local regulations.
- 2.Note that when installing the metal expansion pipe, the pipe shall match with the hole in size. Overlarge hole is prohibited, as it will result in loose pipe and accidental drops.
- 3.There shall be adequate ventilation of the room when the range hood is used at the same time as appliances burning gas or other fuels.
- 4.If the flue aperture is less than air duct aperture, it will influence the fume suction effect and the too long air duct will influence the fume suction effect, too.
- 5.This appliance just for household use only.And it's not allowed to exhaust dangerous or explosive matter or air. It should be put under dry and ventilation environment without dangerous air.

Preparation for installation

●Surrounding

Keep the hood away from too many doors and windows, so as to avoid air convection affecting the efficiency.

●Tools preparation

The hood will be installed with the following tools

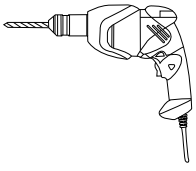

Electric percussion drill

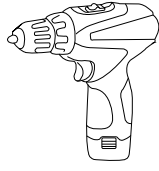

Electric screwdriver

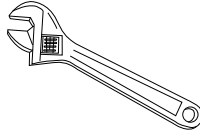

Wrench

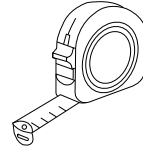

Measuring tape



Gloves

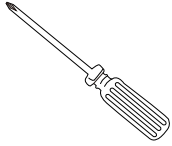

Cross screwdriver

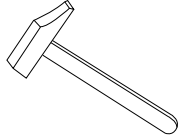

Hammer

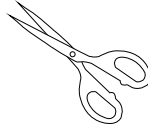

Scissors

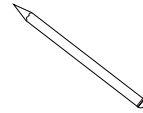

Pencil

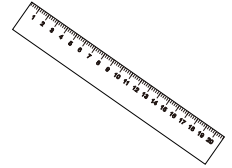

Ruler

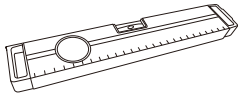

Level meter

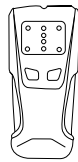

Beam detector

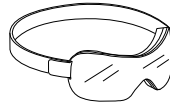

Goggles

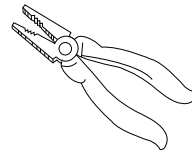

Cutting pliers

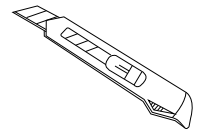

Art knife

Notice

- Installation and circuit setting must be done by experienced professionals. Only a professionally trained person with an installation qualification can install the hood. Non-professionals are not allowed to install, dismantle and repair the hood.
- Please do not power on the hood before installation to avoid electric shock.
- Do not expose the hood if your kitchen is under renovation, because construction materials, dusts, paint, coatings, and emitted gases will corrode and tarnish the hood surface. Therefore, it is recommended to install it after the renovation is completed.
- If you need move the Gas Hob before installing the Range Hood, please close the main valve before moving the Gas Hob.
- Don't install the hood on wood and other combustible walls. The wall shall be made of noncombustible materials with enough strength and the surface shall be flat.
- The hood may have very sharp edges. So, please wear protective gloves during hood installation, cleaning or repair.
- When drilling on the wall or ceiling board, keep away from embedded wires and other concealed devices to avoid electric shock and fire.
- Do not install the hood at a too high position as well as keep the hood free from disturbance of ambient airflow lest the reduction of smoke pumping effect shall occur.
- When making cabinet, please leave space for installation and disassembly of the hood in order to maintain and overhaul the hood.
- When installing, please keep the machine body remain horizontal.
- Please use single phase grounded socket and the hood shall be well grounded (water pipe grounding is not reliable and gas pipeline grounding has risks of causing fire disaster and explosion).
- In order to ensure safety and successful installation, please use standard accessories provided with the hood for installation, otherwise the hood may be at risk of falling down.
- If the power cord is damaged, in order to avoid danger, it must be replaced by manufacturer, professionals of its maintenance department or similar departments. Please do not carry out restructuring, stretching, knotting and squeezing or apply heavy objects to the power cord, etc., otherwise it may cause power cord damage easily, leading to accidents such as electric shock and fire disaster, etc.
- After installation, please clean the surface of the hood, and then supply power for test run.

Installation

The range hood should be installed directly above the stove. In order to ensure the safety and the best effect of oil fume suction, it is suggested that the minimum distance between the lowest installation section of the range hood and the cooker supporting surface on the stove should be 650mm and the maximum should not be greater than 750mm. If the state or region has laws on installation height of the range hood, it is recommended to comply with the laws, but the fume suction effect of the product may be greatly affected.

The range hood can be installed in two modes: with or without an upper cabinet.

Note: 1. The hitching leg must be fixed to the beam with a screw.

2. Please operate with protective gloves and goggles.

3. All data units in the following diagram are expressed in mm.

● Installation without an upper cabinet

1. Open the container and take out the machine, and check the items inside against the packing list.

2. Draw a vertical center line in the installation position, and then use the beam detector to find the beam to fix the hitching leg, and mark it with a pencil; At the same time, open air duct holes in the ceiling according to the dimensions shown in the figure below.

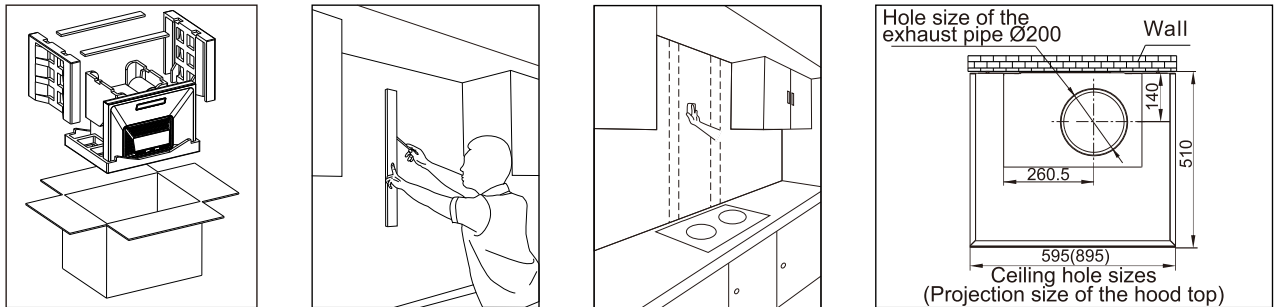

3. Determine the positions to fix the hitching leg and the hitching leg stop block.

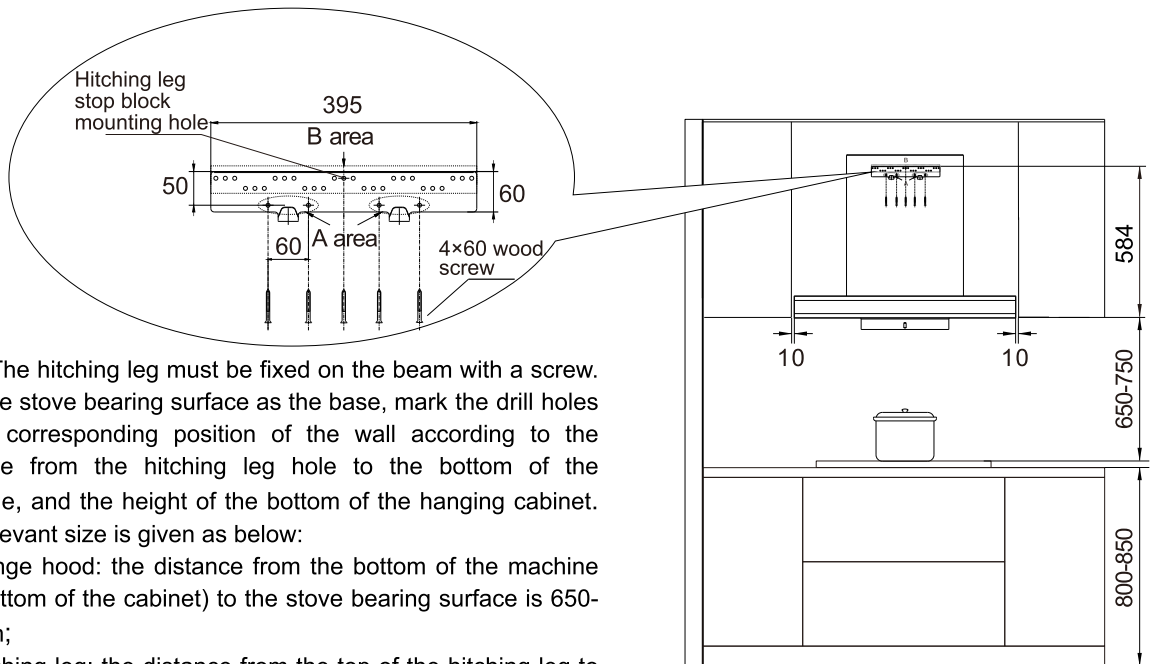

Note: The hitching leg must be fixed on the beam with a screw. With the stove bearing surface as the base, mark the drill holes in the corresponding position of the wall according to the distance from the hitching leg hole to the bottom of the machine, and the height of the bottom of the hanging cabinet. The relevant size is given as below:

1). Range hood: the distance from the bottom of the machine (the bottom of the cabinet) to the stove bearing surface is 650-750mm;

2). Hitching leg: the distance from the top of the hitching leg to the bottom of the machine is 584mm.

4. Fixed hanging feet

1) When the wall of the hanging machine is tile, use a drill bit of $\frac{5}{16}$ "(8mm) in diameter to drill a hole of $2\frac{3}{8}$ "(60mm)- $2\frac{3}{4}$ "(70mm) in depth at the mark (not too big), press bulged tube(tile) into the hole.

2) When the hanging wall is gypsum board, use a screwdriver to screw the bulged tube (gypsum board) into the wall directly at the mark.

Then, at the mark of the hanging foot stopper fixed orifice, drill a hole with a diameter of $\frac{3}{8}$ " (10mm) (not too large) and a depth of 2" (50mm) - $2\frac{3}{16}$ "(55mm), The M6 metal bulged tube is inserted into the hole.

5. Remove M6 metal expansion pipe, nut and washer, and reliably fix the hitching leg with 4×60mm wood screws supplied with the machine. Use a level ruler to make sure the hitching leg is in a horizontal position. Note:

1).The hitching leg must be fixed to the beam with a screw.

2).The A area hole in the figure must be fixed, and the B area hole corresponding to the wooden column must be fixed with the screw.

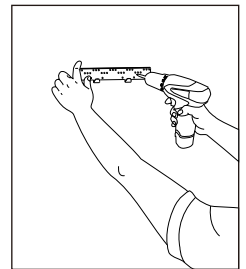
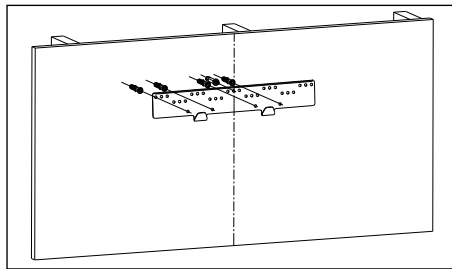
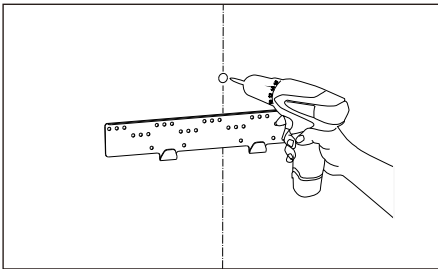

6. Pull the two supports of the attached panel of the mainframe with both hands and pull them upward, tear off the protective film of the panel and the attached panel of the mainframe, and insert the attached panel of the mainframe back along the gap between the panel of the mainframe and the shell.

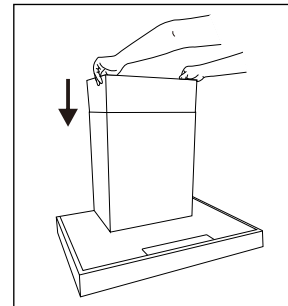
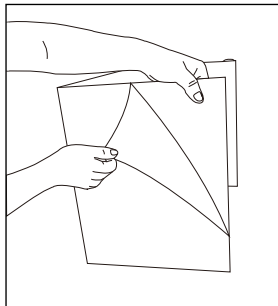
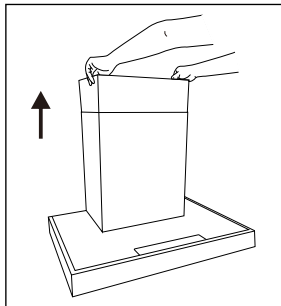

7. Fix the check valve on the range hood as shown in the figure, then lift the range hood and hang the back hook hole up at the hitching leg on the wall at an angle, and use a level ruler to ensure that the machine is installed horizontally.

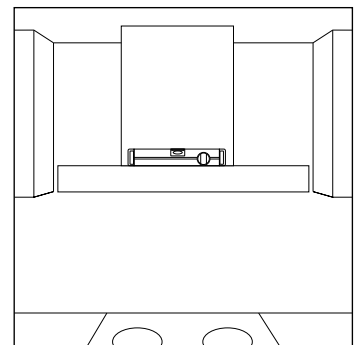
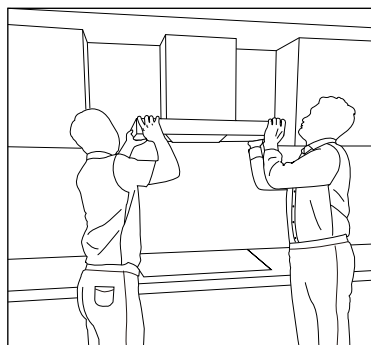
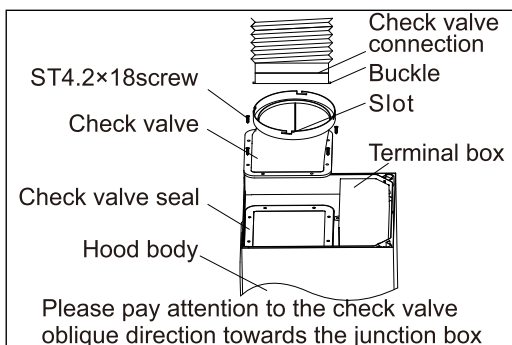

8. After the machine is installed in place, install the hitching leg stop block and the gasket on the M6 metal expansion pipe, and tighten the nut (to prevent the machine from decoupling accidentally under external force).

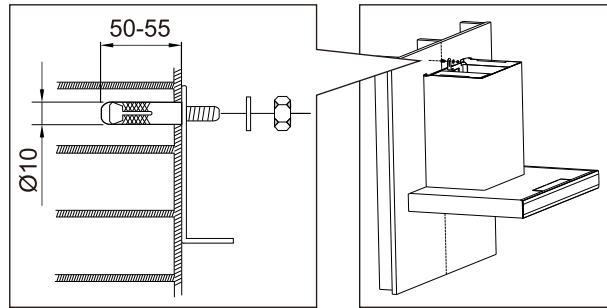

9. Link the aluminum exhaust pipe

Insert the end of aluminum exhaust pipe without fixed strip to the pipe connection and stick with tapes, then straighten the aluminum exhaust pipe and connect it to the public flue outlet (If there is no public flue, please straighten the aluminum exhaust pipe to the outdoors). This can be done directly when the public flue outlet or wall hole is larger than the aluminum exhaust pipe. Otherwise, there are five types of pipe small ends (OD:140,150,160,170 and 180 respectively) to be chosen from according to the hole size. Then cut the excess part smaller than public flue outlet or wall hole with scissors.

Then, insert one end of the aluminum foil duct with the air duct fixing strip into the outer ring of the check valve interface, and then distribute and fix it with three ST4.2×8 screws. The tube tape is sealed. Finally, put the four snaps of the check valve interface into the four slots of the check valve, and rotate the clock to fix the air duct in the check valve.

Note: During installation, straighten the aluminum exhaust pipe to avoid noises in semi-stretched state. Excess part may be cut with a wire cutter.

The exhaust wall hole diameter shall be close to that of the exhaust pipe, which shall not be too small. Otherwise, it will cause poor exhaust efficiency, more noises and lower volume, etc. The connection between the pipe and the hole or the public flue must be sealed tightly to ensure that the pipe and the check valve or public flue is connected securely. The blades at the check valve connection or public flue connection must be flexible.

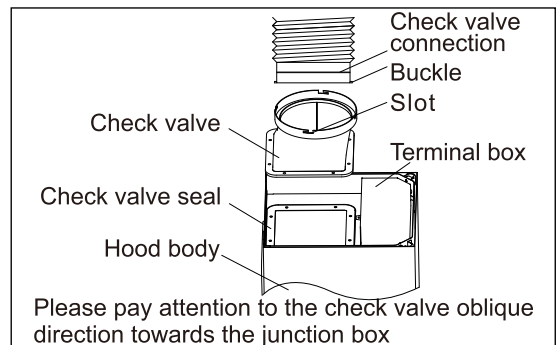
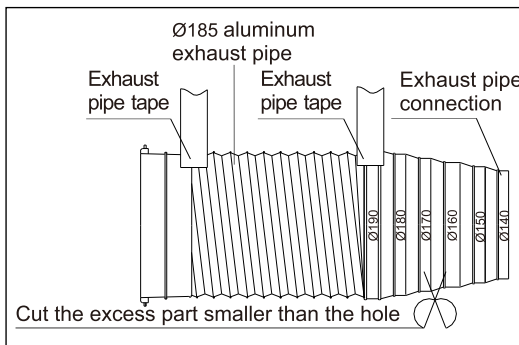

10. At this time, there is still a certain gap between the attached panel of the mainframe and the roof, so the attached panel of the mainframe should be pulled out and pushed to contact with the roof, and then the attached panel of the mainframe should be fixed on the roof with ST4.2×18 screws.

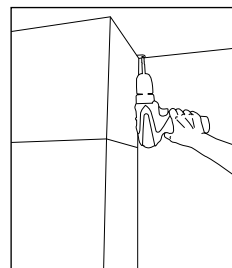
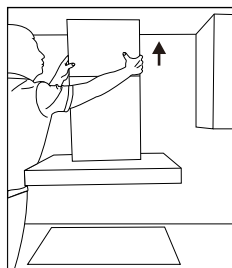

11. After installation, the whole machine must be kept horizontal. In the end, insert the oil cup into the hitching leg on the bottom of the mesh enclosure and power it for trial operation.

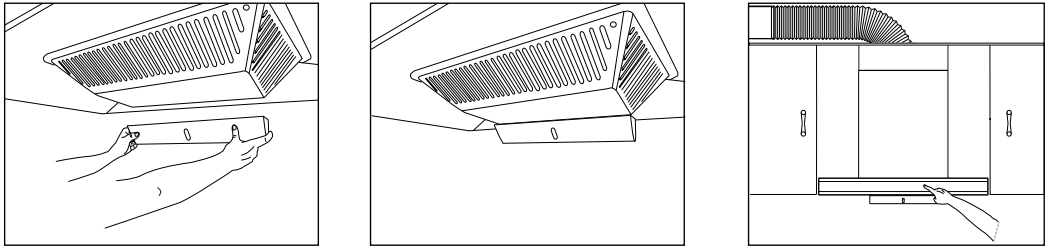

● Installation with an upper cabinet

1. Open the container and take out the machine, and check the items inside against the packing list.
2. Draw a vertical center line in the installation position, and then use the beam detector to find the beam to fix the hitching leg, and mark it with a pencil; At the same time, open air duct holes in the ceiling according to the dimensions shown in the figure below.

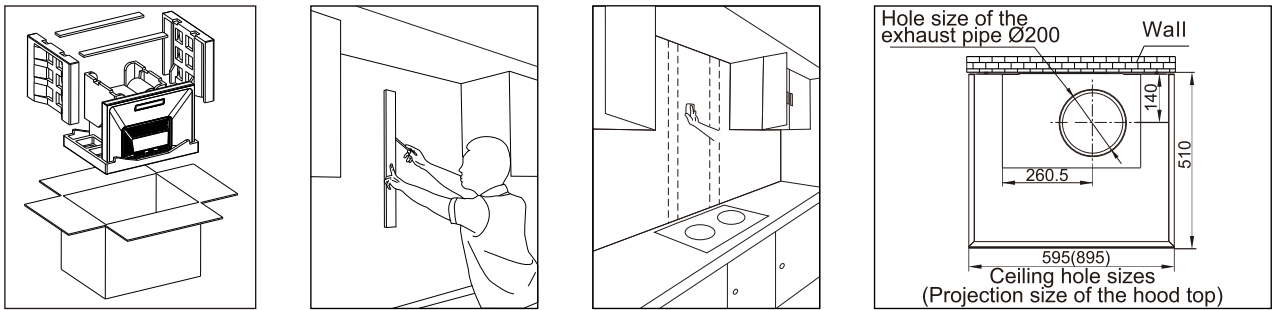

3. Determine the positions to fix the hitching leg and the hitching leg stop block.

Note: The hitching leg must be fixed on the beam with a screw.

With the stove bearing surface as the base, mark the drill holes in the corresponding position of the wall according to the distance from the hitching leg hole to the bottom of the machine, and the height of the bottom of the hanging cabinet. The relevant size is given as below:

- 1). Range hood: the distance from the bottom of the machine (the bottom of the cabinet) to the stove bearing surface is 650mm-750mm;
- 2). Hitching leg: the distance from the top of the hitching leg to the bottom of the machine is 584mm.

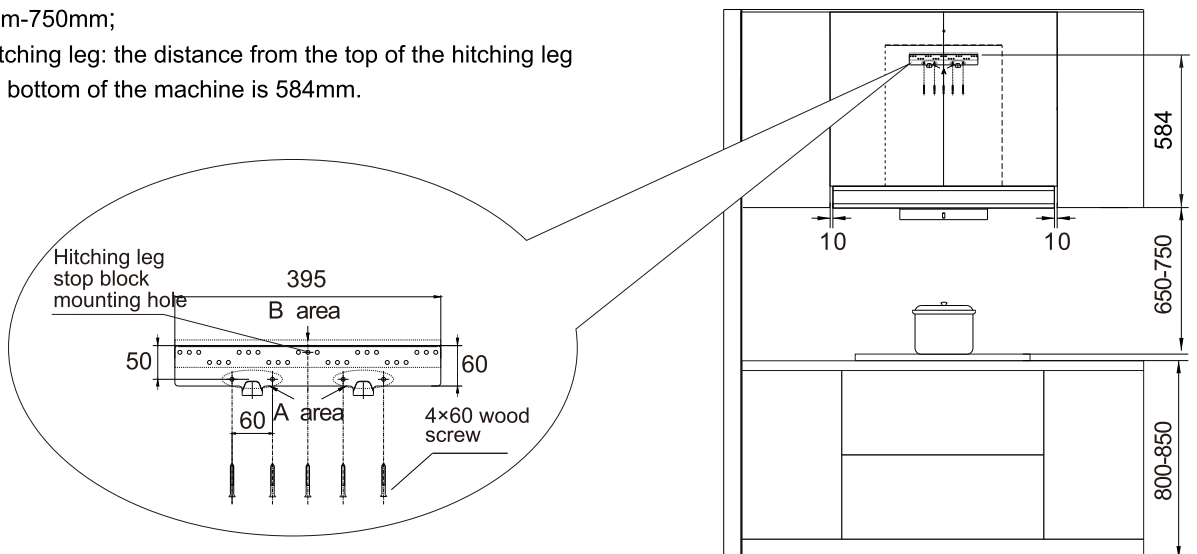

4. Fixed hanging feet

1) When the wall of the hanging machine is tile, use a drill bit of $\frac{5}{16}$ "(8mm) in diameter to drill a hole of $2\frac{3}{8}$ "(60mm)- $2\frac{3}{4}$ "(70mm) in depth at the mark (not too big), press bulged tube(tile) into the hole.

2) When the hanging wall is gypsum board, use a screwdriver to screw the bulged tube (gypsum board) into the wall directly at the mark.

Then, at the mark of the hanging foot stopper fixed orifice, drill a hole with a diameter of $\frac{3}{8}$ " (10mm) (not too large) and a depth of 2" (50mm) - $2\frac{3}{16}$ "(55mm), The M6 metal bulged tube is inserted into the hole.

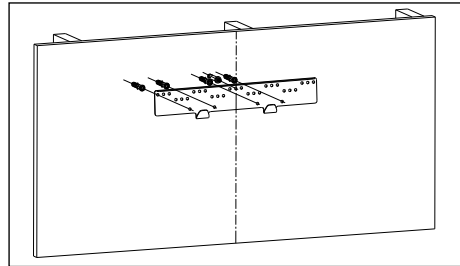
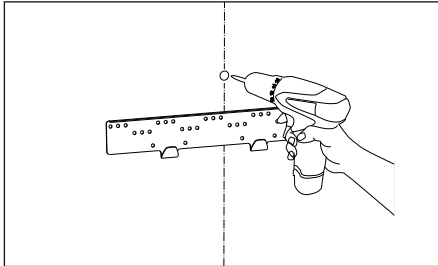

5. Remove M6 metal expansion pipe, nut and washer, and reliably fix the hitching leg with 4×60mm wood screws supplied with the machine. Use a level ruler to make sure the hitching leg is in a horizontal position. Note:

1).The hitching leg must be fixed to the beam with a screw.

2).The A area hole in the figure must be fixed, and the B area hole corresponding to the wooden column must be fixed with the screw.

6.Make holes on the cabinet floor according to the size shown in the illustration.

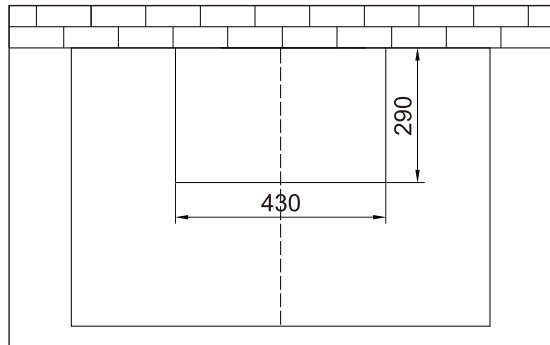
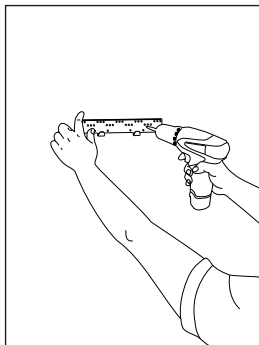

7. Pull the two supports of the attached panel of the mainframe with both hands and pull them upward, tear off the protective film of the panel and the attached panel of the mainframe, and insert the attached panel of the mainframe back along the gap between the panel of the mainframe and the shell.

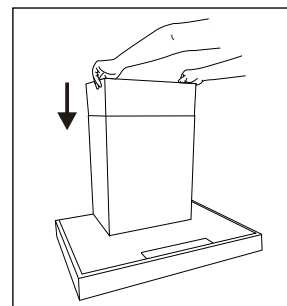
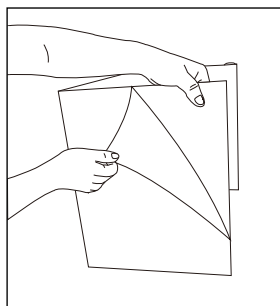
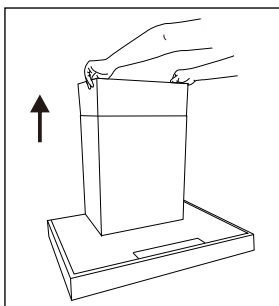

8. Fix the check valve on the range hood as shown in the figure, then lift the range hood and hang the back hook hole up at the hitching leg on the wall at an angle, and use a level ruler to ensure that the machine is installed horizontally.

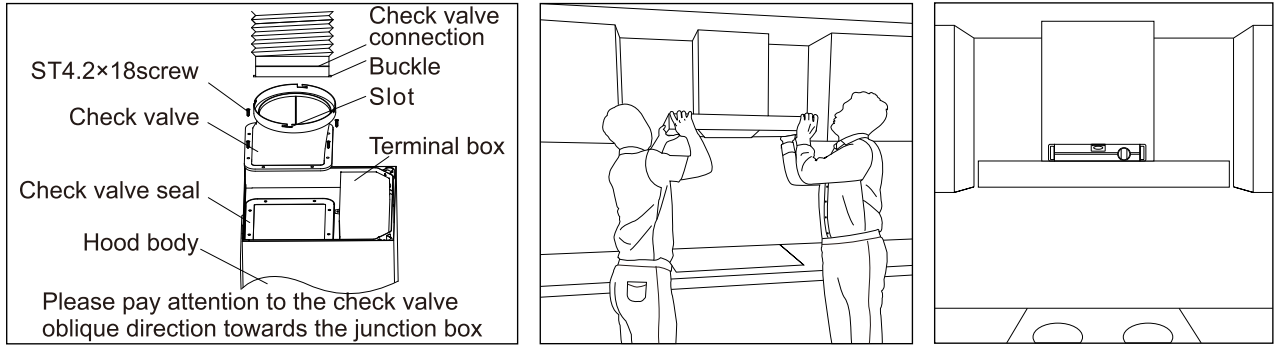

9. After the machine is installed in place, install the hitching leg stop block and the gasket on the M6 metal expansion pipe, and tighten the nut (to prevent the machine from decoupling accidentally under external force).

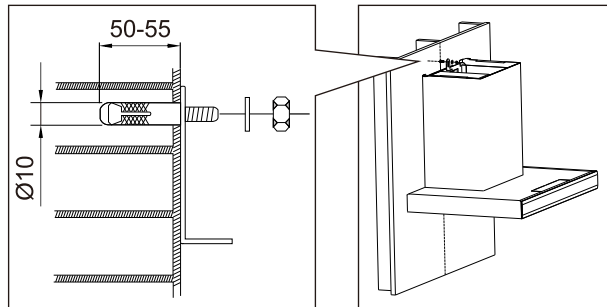

10. Link the aluminum exhaust pipe

Insert the end of aluminum exhaust pipe without fixed strip to the pipe connection and stick with tapes, then straighten the aluminum exhaust pipe and connect it to the public flue outlet (If there is no public flue, please straighten the aluminum exhaust pipe to the outdoors). This can be done directly when the public flue outlet or wall hole is larger than the aluminum exhaust pipe. Otherwise, there are five types of pipe small ends (OD:140,150,160,170 and 180 respectively) to be chosen from according to the hole size. Then cut the excess part smaller than public flue outlet or wall hole with scissors.

Then, insert one end of the aluminum foil duct with the air duct fixing strip into the outer ring of the check valve interface, and then distribute and fix it with three ST4.2×8 screws. The tube tape is sealed. Finally, put the four snaps of the check valve interface into the four slots of the check valve, and rotate the clock to fix the air duct in the check valve.

Note: During installation, straighten the aluminum exhaust pipe to avoid noises in semi-stretched state. Excess part may be cut with a wire cutter.

The exhaust wall hole diameter shall be close to that of the exhaust pipe, which shall not be too small. Otherwise, it will cause poor exhaust efficiency, more noises and lower volume, etc. The connection between the pipe and the hole or the public flue must be sealed tightly to ensure that, the pipe and the check valve or public flue is connected securely. The blades at the check valve connection or public flue connection must be flexible.

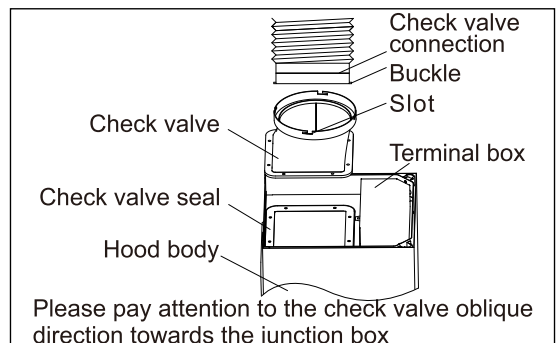
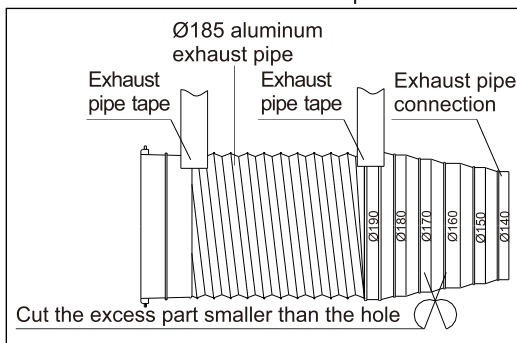

11. After installation, the whole machine must be kept horizontal. In the end, insert the oil cup into the hitching leg on the bottom of the mesh enclosure and power it for trial operation.

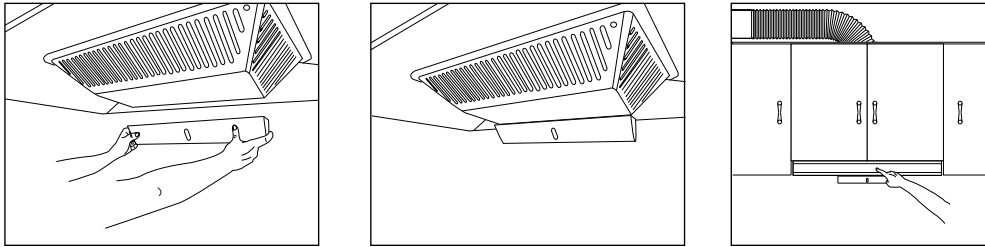

User Manual

Switch control panel







Hand wave induction

Lighting

Airflow slip contact

Power

When the power is turned on, the buzzer sounds and the power is turned on.

 <p>Power</p>	<p>Press the power button to enter the power-on state, and the power button icon lights up for a long time.</p> <p>① In the state of the fan not running, press the power button to enter the shutdown state.</p> <p>② In the fan running state, press the power button, the hood will enter the delayed shutdown state and automatically turn off all functions after 1 minute; during the delay, the delayed shutdown can be canceled by following the lighting key, sliding or clicking the air volume sliding contact bar.</p> <p>③ In the power-on state, if there is no operation within 3 minutes, it will enter the power-off state.</p>
 <p>Lighting</p>	<p>On or off state, according to the Ming key, you can turn on or off the lighting.</p>
 <p>Airflow slip contact</p>	<p>After the power button is turned on, slide or click the air volume sliding contact bar, the fan starts to work. According to the length of the air flow control bar, there are 1-9 gears (Three light bars represent a gear), users can choose the right gear according to their needs. Click or slide to the leftmost blank of the airflow contact strip to turn off the airflow.</p>
 <p>Hand wave induction</p>	<p>① In the state of the machine, the first wave of the hand automatically open the power button; wave again in response to the high gear function; high gear state wave in response to the maximum gear function;</p> <p>② In the off state, press and hold the "Lighting+The leftmost blank of the airflow slide contact strip" key at the same time to turn the sensor function on or off.</p>

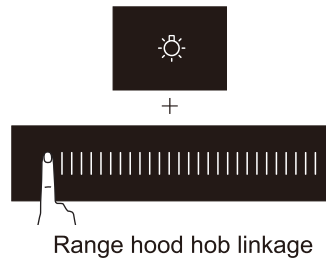

- ① When the power button is on, press and hold the "Lighting+The leftmost blank of the airflow slide contact strip (finger indication)" button to enter the pairing mode, the lighting button and the icon of the first frame of the airflow slider on the left will flash. If the connection is successful, the icon will light up for a long time and then go out. If no device is connected or the pairing fails within 3 minutes, the icon will go out and end the pairing process. During the pairing process or after successful connection, long press the "Lighting+The leftmost blank of the airflow slide contact strip" key to cancel the pairing or disconnect.
- ② When the match is successful, the cooker ignites at this time, and if the hood is not turned on the airflow or the airflow is less than the strong gear, the hood is linked to start the strong gear airflow. After the stove is turned off (all stoves are turned off), if the hood has airflow, it will linkage into delayed shutdown state, if there is no airflow, it will linkage into shutdown state.

Maintenance

⚠ Warning

1. There is a fire risk if cleaning is not carried out in accordance with the instructions.
2. Cleaning and maintenance shall be conducted under outage. Electrical components such as motor, switch, and connector shall not be spoiled by water so as to prevent from accidents.
3. It's prohibited to wash with water so as to prevent accidents.
4. Stove fire shall be extinguished timely when it is not used; do not flambe under the range hood and it's prohibited to bake food under range hood directly to prevent range hood from damaging and causing accidents.
5. If the supply cord is damaged, it must be replaced by the manufacturer, its service agent or similarly qualified persons in order to avoid a hazard.
6. Accessible parts may become hot when used with cooking appliances.

Considerations

● The hood shall be cleaned and maintained regularly depending on the surroundings, so as to keep its cleanness & efficiency and extend its service life.

We recommend that: Clean the outer surface of range hood after each cooking.

● It is recommended to use a neutral detergent to clean instead of strong detergents, and dry with a soft cloth. If your range hood is a mechanical switch, and should avoid the cleaning agent from contacting each control button.

● Do not allow stains to stay on the surface of the hood for too long.

● Please do not use cleaning balls, brushes and other rough objects to clean the hood to prevent the body surface from scratching.

● When cleaning or maintaining the hood, please wear protective gloves to prevent wounding during wiping.

● Please regularly check and clean the oil cup. Please check regularly and clean the oil cup, hold the oil cup with both hands when the oil in the oil cup is about to reach the tick mark. Shift out and remove the waste oil.

● The range hood shall be started before cooking.

● Please unplug it during long-term shutdown, but please do not pull hard.

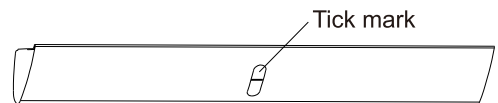

Removal of Components

⚠ Warning

1. As a general rule, the hood body does not need to remove, and removal shall be done by professional maintainers. Nonprofessionals are forbidden to remove, install and repair the hood.
2. Before cleaning, installation or maintenance for the range hood, cut off the power supply to avoid electric shock.

Note: The installation procedures of the following components are in reverse with the removal. Please wear protective gloves during operation to prevent the sharp edge of metal hurting your hands.

Removal of light



Insert a small flat head screwdriver or something sharp in the gap between the light cover and hood.

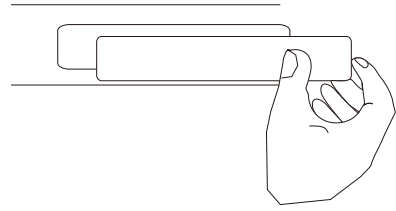

Raise the spotlight outward forcibly to remove it from the hood. Pull out the connector to replace the spotlight.

Lamp image		Lamp information	
		Lamp Type	Rectangular LED
		Max Power	2W
		Voltage	12VDC
		Dimension	See the lamp image

Remove of switch

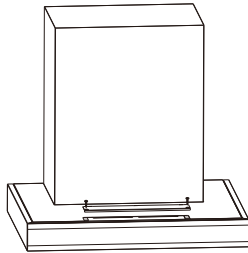

Unscrew the two screws on the small cover and remove the small cover.

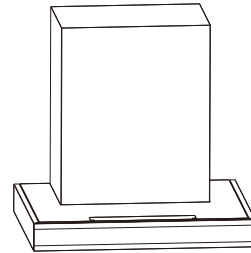

Unscrew the two screws on the switch cover and rotate the switch cover. The switch assembly can be withdrawn and repaired or replaced.

Removal and installation of the whole body

Removal steps:

1. Pull out the plug;
2. Unscrew the four screws from the back of the main hood panel. Tilt the panel forward to a certain angle, and then pull it up forcibly;
3. Remove the drawing panel from the main hood panel;
4. Remove the sound absorption sponge first, and then use a cross screwdriver to unscrew the fastening screws on acoustic baffle to remove the baffle;
5. Unscrew the fastening screws on the retaining ring to remove the retaining ring;
6. Unscrew the cap clockwise and take out the impeller vertically;

The installation steps are opposite to the removal steps. (When you install the impeller, please rub some lubricating oil on the shaft hole of it.)

Note: Step 3 is unnecessary if no drawing panel is installed.



In general, the range hood body does not need to be removed. The removal needs to be completed by professional maintenance staff.

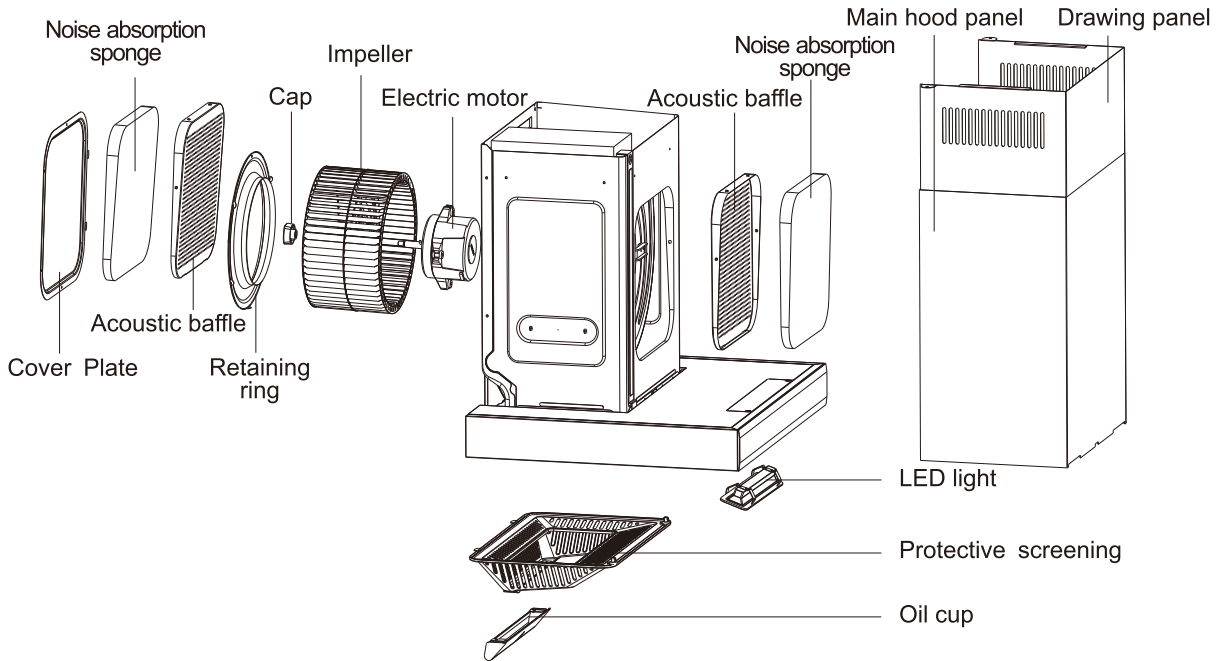

Circuit Diagram

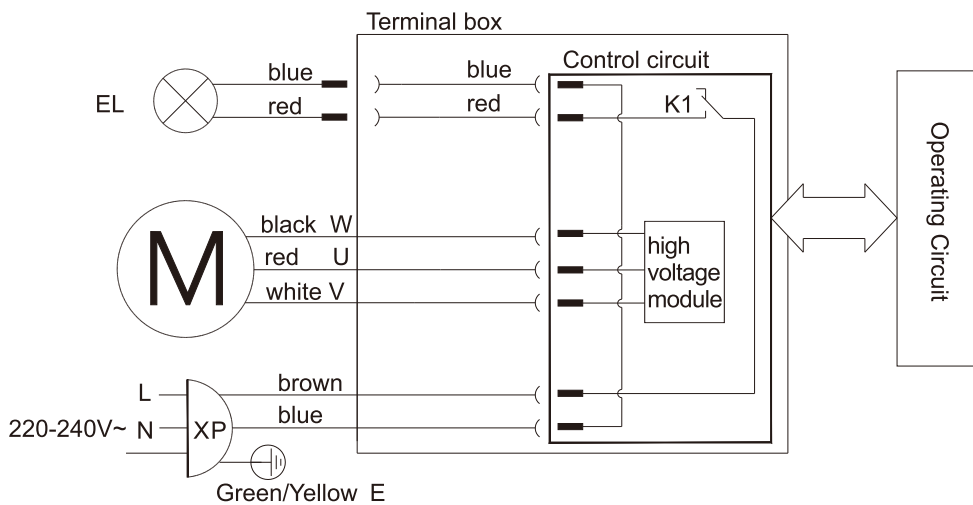

Troubleshooting of General faults

Serial number	Fault	Cause	Solution
1	No response after pressing any icon (e. g. the impeller does not rotate, or the light is off)	The power plug is not connected properly or there is power failure	Plug in the power plug
2	Pressing the lighting icon, the headlamp is not lit	The light is damaged or poorly connected	Replace the light or plug in the plug
3	Induced current exists on the hood body may paralyze hands	The power socket is not grounded well	Use single-phase three-pole socket and well grounded
4	Abnormal sound during impeller running	The impeller is loose, and the cap is not tightened	Tighten the cap
5	No oil in the oil cup after a period of time	The hood body is tilt	Adjust the body to the horizontal state
 Warning	1. When connecting or replacing the plug, please unplug the power plug. 2. If the range hood's power cords are damaged, it must be replaced by our company's professional maintenance staff.		

Edition: A/0

Publication Date: June, 20, 2022

ROBAM